

# CONTENT

Foreword .....	1
1. RichAuto system composition .....	4
1.1 System composition .....	4
1.2 Description of Each Component .....	5
2. Instruction to Handle controller keyboard .....	8
2.1 Introduction .....	8
2.2 Usage .....	8
2.3 Detail information for key functions .....	10
3. Wiring Instructions .....	13
3.1 RichAuto Stepping wiring instructions .....	13
3.2 Patch Board I / O Description .....	14
3.3 Hardware Connection.....	19
3.4 Commissioning of The Machine and Control System.....	26
4. Menu direction .....	26
4.1 Menu category .....	26
4.2 Menu detail .....	26
5. Machine operation.....	38
5.1 Return home .....	38
5.2 Import processing files .....	38
5.3 Manual processing operation .....	39
5.4 Automatic machining operation .....	41
5.5 Processing operations .....	44
5.6 Advanced Processing .....	48
PS 1. Handle operating system upgrades .....	52

## ● Foreword

### System Introduction:

**RichAuto** is CNC motion control system independently developed by Beijing ruizhi tianhong and it can be widely applied to machinery, advertisement, woodworking, mold engraving machine, laser, flame, plasma cutting machine, and so on in the machine control field.

**RichAuto** make DSP as the core control system, High-speed processing operation is the microcontroller, PLC systems can't match; Use embedded structure, High degree of integration, Strong stability, easy to installation and operation; U disk support, Removable storage card reader, With USB Interface, High speed transfer, Plug and play the full realization of all work offline。

### Characteristics:

1. System deploy standard X, Y, Z axis motion control method ,Support the rotation axis (C axis) control, Enables to switch the processing of surface and processing of rotation ; up extended to X, Y, Z, C four-axis motion control, Implementation four axis interlocking Control.
2. Multi I / O Point Control, there is eight input and output signals in every basic I / O signal node, Expansion I / O nodes can be expanded to 32 input and output signals。
3. Support the standard G code, PLT format instructions; support domestic and international mainstream CAM software, such as: Type3, Art cam, UG, Pro / E, Master CAM, Cimatron, Wentai etc.
4. Provide with power-down protection. Instantaneous power processing system to automatically save the current processing of information (file name, current line number processing, processing speed, spindle threshold), when power again machine moves back, the system automatically prompts the user to restore the processing

ADD.: Beijing haidian district shangdi three street jiahua building A308. P.C.: 100085.

Dell: 010-62970368 82923063. Fax: 82920078 URL : [www.richnc.com.cn](http://www.richnc.com.cn)

- before power down, the processing operations become more humanity.
5. Support breakpoint memory, file selection, processing. Save 8 different breakpoint processing information.
  6. Multi-coordinate memory function. Provide nine working coordinate system, the user can switch among the 9 coordinate, each coordinate system can save a process origin information.
  7. Support online adjust spindle operating frequency. The spindle frequency from 0 to maximum frequency is divided into 8 thresholds; 0 - 7 threshold can be processed directly adjust up and down without suspend processing.
  8. Support adjust speed ratio online. Users can adjust the speed ratio, to adjust the processing speed and empty running speed, speed ratio values from 0.1-1, Ascending or descending per 0.1 numerical.
  9. Simply manual operate mode. In manual mode, the system provides three kinds of sports concluding continuous, step (crawl), distance, manual operation became more simple and convenient.
  10. Identifies M code, F code and other development commands, can open a special code based on user needs.
  11. Built-in 512 M memory.
  12. Unique handheld form factor with one hand to hold. Own liquid crystal display and 16 key keyboard , operate intuitive and flexible, no longer dependent on the computer, the full realization of full offline operation
  13. Comes with USB communications port, file transfer efficiency can be directly read U disk, card reader file, Plug and Play.
  14. Self-test function, the system comes with I / O port signal detection capabilities, ease of remote maintenance.
  15. Processing with high-speed and smooth, support high subdivide, make sure

ADD.: Beijing haidian district shangdi three street jiahua building A308. P.C.: 100085.

Dell: 010-62970368 82923063. Fax: 82920078 URL : [www.richnc.com.cn](http://www.richnc.com.cn)

- processing with high accuracy and high speed.
16. Unique in Chinese-English to show double-interface, can be realized in switching Chinese and English show online.
  17. Multi-language display. Support for Simplified Chinese, Traditional Chinese, English, Russian, French and other languages, can be customized according to user needs.
  18. System can support automatic dynamic upgrades, convenient to remote operation, remote maintenance.

## Notice:

1. Forbid in strong interference and strong magnetic field environment.
2. Do not plug signal transmission cable which connect hand-held controller to the machine.
3. When processing U disk files, do not pull out the U disk, to prevent interruption of data transmission.
4. Strictly forbidden metal, dust and other conductive materials into the hand-held controller.
5. Ground wire should be connected machine housing to ensure safety and to prevent bring in interference .
6. Unauthorized removal prohibited, no user repairable parts inside.
7. If do not use for a long time, please power-down, and properly maintained.
8. Note water, dust and fire when using.

# 1. RichAuto system composition

## 1.1 System composition

**RichAuto** control system contains the following parts: A hand-held motion controller ,a line adapter board, a fifty pin data transmission cable, an USB communication cable.

### RichAuto accessories schematic diagram



Hand- held motion controller

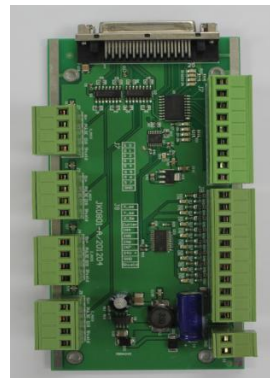

adapter board



50 pin data transmission cable



USB communication cable

Figure 1-1

ADD.: Beijing haidian district shangdi three street jiahua building A308. P.C.: 100085.

Dell: 010-62970368 82923063. Fax: 82920078 URL : [www.richnc.com.cn](http://www.richnc.com.cn)

## 1.2 Description of Each Component

1. Handle: the core of the lower computer, it contains six modules.



**Handle**

- (1).LCD: Resolution of 128 \* 64 LCD display, To display the machine motion, and the information, such as the system settings and other information.
- (2).KEYBOARD: It contains 16 keys to input the system parameter information and operate the machine.
- (3). U Disk Interface: external memory access ports to U disk and the memory card. The file format can be identified by the external memory is FAT16/32.
- (4).50-pin Data Cable Jack: through 50 pin data transmission cable and line adapter can achieve the connection between system and the machine. The system sent the movement to machine motion actuator.

ADD.: Beijing haidian district shangdi three street jiahua building A308. P.C.: 100085.

Dell: 010-62970368 82923063. Fax: 82920078 URL : [www.richnc.com.cn](http://www.richnc.com.cn)

**(5).USB Communication Indicator Light:** the direction for communication between the PC and the lower computer. Indicator lights turn on which means connection is successfully, while it means fail to connect.

**(6).USB Communication Port:** USB data line access port. It is used to connect the host computer with r computer.

**2. Interface Board:** The operation between the low computer and machine is completed by the link of the interface boards. It contains 6 parts.

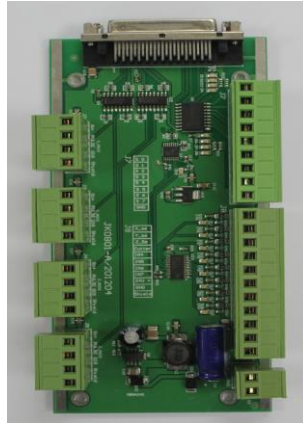

### **Interface board**

**(1).** 50-pin data cable jack: The connection between the system and the machine can be completed through 50 pin data transmission cable and line adapter and then the system can sent the movement signal to machine motion actuator.

**(2).** Output control terminal: It can control start and stop of the spindle and gear change. Different connection ways refer to different control. You can check the details in the menu notes, "spindle set the option" Help.

ADD.: Beijing haidian district shangdi three street jiahua building A308. P.C.: 100085.

Dell: 010-62970368 82923063. Fax: 82920078 URL : [www.richnc.com.cn](http://www.richnc.com.cn)

**(3).** Input control terminal: The input terminal for the machine origin detection switch signal.

**(4).**Power supply terminal: the input terminal for system switching Power Supply. (DC24V 3A)

**(5).**Motor drive control terminal: the output terminal for drive control line.

### 3. 50 pin data transmission cable



### 4. USB communication cable





## 2 Instruction to Handle controller keyboard

### 2.1 Introduction:

**RichAuto** system handle controller defines 16 operation keys according to the system functional requirements. Each key has one or more functions under different work status;

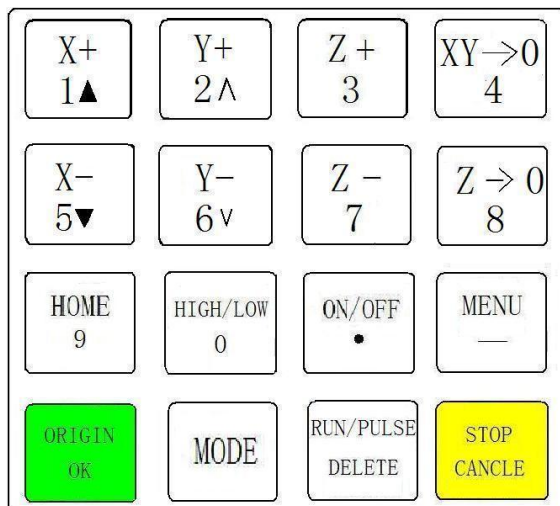

16-key layout

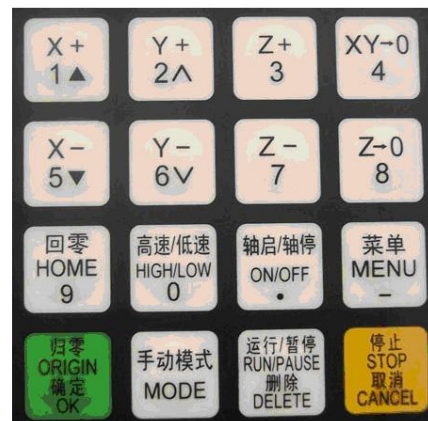

Chinese Button really making plans

### 2.2 Usage:





**RichAuto** control system divided the key's operation into one-touch button operation, and the combined-key operation.

One Touch: Press one button on handheld motion controller.

Combined-key operation: Press two buttons at the same time to achieve the operation;



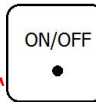

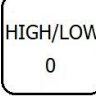

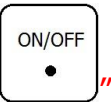

The operation step: press one main function key and meanwhile press a second accessibility key, and then release the two keys at the same time to realize the combined-key operation.

**PS:** Commonly used combined-key list:

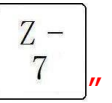
	Combined-key	Function
<b>1</b>	 + "0-9" Number keys	to switch the coordinate system (0 for the mechanical coordinate system , 1 - 9 for the work coordinate system)
<b>2</b>	 + 	Start Z-axis automatic tool setting
<b>3</b>	 + "1-8" Number keys	to start the break processing (support number 1 - 8)
<b>4</b>	 + 	to start the advanced processing modes

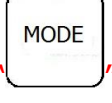

ADD.: Beijing haidian district shangdi three street jiahua building A308. P.C.: 100085.

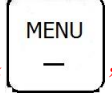

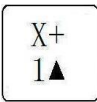
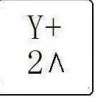

Dell: 010-62970368 82923063. Fax: 82920078 URL : [www.richnc.com.cn](http://www.richnc.com.cn)

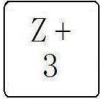
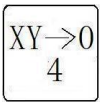
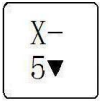
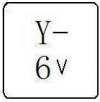
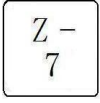
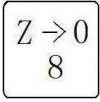
5	 +  / 	To switch gear shaft
6	 + 	Repeat last time processing
7	 + 	Operate machine by entering coordinates parameters
8	 +  键	System update

## 2.3 Detail information for key functions:

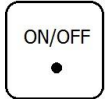
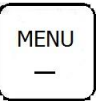
key	Function
	Positive movement of X axis, Menu upward , figure 1 inputting
	Positive movement of Y axis, accelerate process speed, figure 2 inputting, different property selecting in Menu

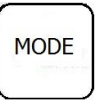
	Positive movement of Z axis, figure 3 inputting, rise spindle speed in process
	Working origin of X axis and Y axis setting, figure 4 inputting
	Negative movement of X axis; Menu downward, figure 5 inputting
	Negative movement of Y axis; slowdown process speed; figure 6 inputting different property selecting in Menu
	Negative movement of Z axis, figure 7 inputting, spindle speed adjusting in process
	Z axis origin setting ; figure 8 inputting
	Axes home to machine tool origin, figure 9 inputting
	Manual moving mode, high speed or low speed selection, figure 0 inputting

	<p>Spindle startup/stop, decimal point inputting</p>
	<p>Menu setting entering, negative symbol inputting, multi process state checking</p>
	<p>All axes go working origin: confirm of motions /inputting/operating</p>
	<p>Manual move, continue, step and distance modes selection</p>
	<p>Cut process running/pause/inputted words delete</p>
	<p>High/low speed parameter adjust, Cut process stop/selections, inputting and operating cancel</p>

### 3. Wiring Instructions

#### 3.1 RichAuto Stepping wiring instructions

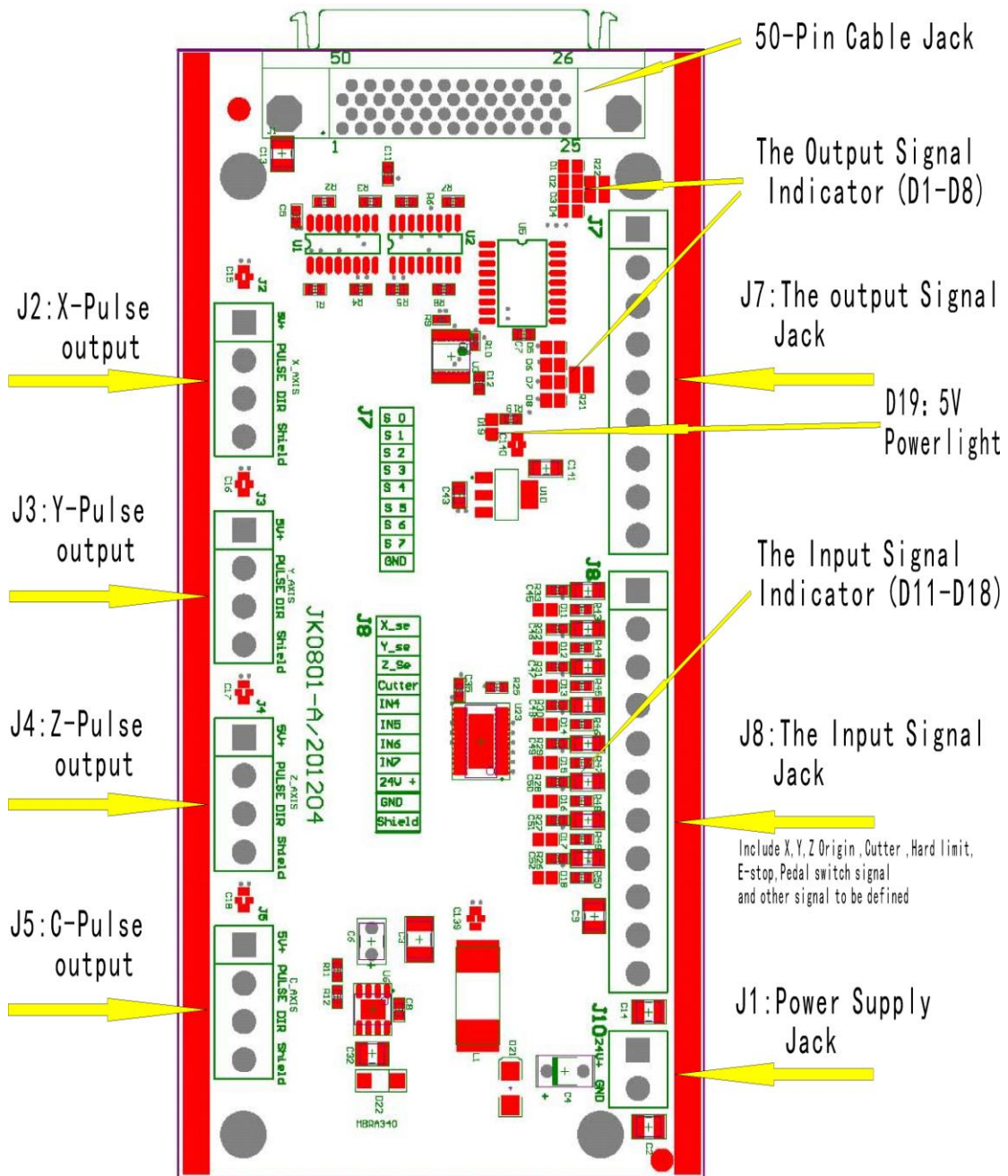

ADD.: Beijing haidian district shangdi three street jiahua building A308. P.C.: 100085.

Dell: 010-62970368 82923063. Fax: 82920078 URL : [www.richnc.com.cn](http://www.richnc.com.cn)

### 3.2 Patch Board I / O Description

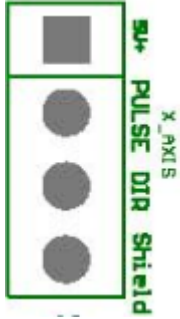
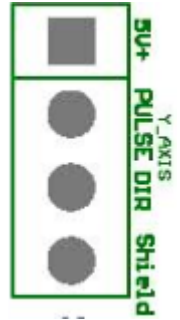
Port label	Port definition	Pin Definition	Pin functions and parameters	Notes
<b>J10</b> 	System Main power	System main power supply side	System main power supply terminal , interface board give DC 5V for system. When F3 shorted can provide voltage to XYZ	Power area: DC10V~DC24V/3A
<b>J 2</b> 	X-axis pulse output port	Were positive signal output port	X-axis drive common anode power supply terminal 5V output	Do not impose voltage on this pin
		Pulse signal output port	X-axis drive pulse signal output port, the output voltage $\geq 3V$ drive current $\leq 8mA$	
		direction signal output port	X-axis direction of the drive signal output port output voltage $\geq 3V$ drive current $\leq 8mA$	
		Shield connection port	X-axis drive signal output voltage line terminal shield	Do not use this port for the grounding port
<b>J 3</b> 	Y-axis pulse output port	Were positive signal output port	Y-axis drive common anode power supply terminal 5V output	Do not impose voltage on this pin
		Pulse signal output port	Y-axis drive pulse signal output port, the output voltage $\geq 3V$ drive current $\leq 8mA$	
		direction signal output port	Y-axis direction of the drive signal output port output voltage $\geq 3V$ drive current $\leq 8mA$	
		Shield connection port	Y-axis drive signal output voltage line terminal shield	Do not use this port for the grounding port

ADD.: Beijing haidian district shangdi three street jiahua building A308. P.C.: 100085.

 Dell: 010-62970368 82923063. Fax: 82920078 URL : [www.richnc.com.cn](http://www.richnc.com.cn)

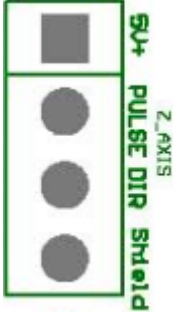
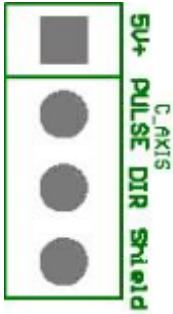
Port label	Port definition	Pin Definition	Pin functions and parameters	Notes
<b>J 4</b> 	<b>Z-axis pulse output port</b>	<b>Were positive signal output port</b>	<b>Z-axis drive common anode power supply terminal 5V output</b>	<b>Do not impose voltage on this pin</b>
		<b>Pulse signal output port</b>	<b>Z-axis drive pulse signal output port, the output voltage <math>\geq 3V</math> drive current <math>\leq 8mA</math></b>	
		<b>direction signal output port</b>	<b>Z-axis direction of the drive signal output port output voltage <math>\geq 3V</math> drive current <math>\leq 8mA</math></b>	
		<b>Shield connection port</b>	<b>Z-axis drive signal output voltage line terminal shield</b>	<b>Do not use this port for the grounding port</b>
<b>J 5</b> 	<b>C-axis pulse output port</b>	<b>Were positive signal output port</b>	<b>C-axis drive common anode power supply terminal 5V output</b>	<b>Do not impose voltage on this pin</b>
		<b>Pulse signal output port</b>	<b>C-axis drive pulse signal output port, the output voltage <math>\geq 3V</math> drive current <math>\leq 8mA</math></b>	
		<b>direction signal output port</b>	<b>C-axis direction of the drive signal output port output voltage <math>\geq 3V</math> drive current <math>\leq 8mA</math></b>	
		<b>Shield connection port</b>	<b>C-axis drive signal output voltage line terminal shield</b>	<b>Do not use this port for the grounding port</b>

ADD.: Beijing haidian district shangdi three street jiahua building A308. P.C.: 100085.

 Dell: 010-62970368 82923063. Fax: 82920078 URL : [www.richnc.com.cn](http://www.richnc.com.cn)

15

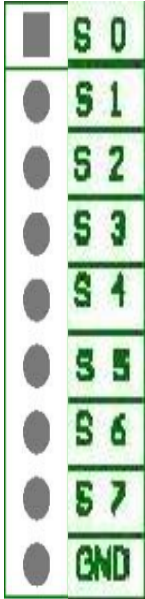

Port label	Port definition	Pin Definition	Pin functions and parameters	Notes
<b>J 7</b> 	Output Control terminal	<b>S0: Spindle ON/OFF</b>	Connect to FWD of inverter	Output Low level signal
		<b>S1: speed 1</b>	Connect to inverter to control speed	Output Low level signal
		<b>S2: speed 2</b>	Connect to inverter to control speed	Output Low level signal
		<b>S3: speed 3</b>	Connect to inverter to control speed	Output Low level signal
		<b>S4: definable</b>	user-defined signal	Output Low level signal
		<b>S5: Work LED</b>	Light when system works	Output Low level signal
		<b>S6: definable</b>	user-defined signal	Output Low level signal
		<b>S7: definable</b>	user-defined signal	Output Low level signal
		<b>GND:output GND</b>		<b>GND connect to this terminal in control inverter speed mode</b>

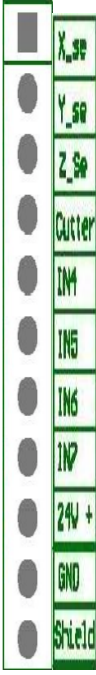

**PS:** All the pin terminals are for the parties sort the mouth as the first one, the bit serial extended direction of the arrow.

Port label	Port definition	Pin Definition	Pin functions and parameters	Notes
<b>J 8</b> 	input Control terminal	<b>X_se: X origin sensor                      Signal Input</b>	<b>X origin sensor signal input                      terminal</b>	<b>Input low level signals</b>
		<b>Y_se: Y origin sensor                      Signal Input</b>	<b>Y origin sensor signal input                      terminal</b>	<b>Input low level signals</b>
		<b>Z_se: Z origin sensor                      Signal Input</b>	<b>Z origin sensor signal input                      terminal</b>	<b>Input low level signals</b>
		<b>CutterTool-setting                      sensor signal input</b>	<b>Tool-setting sensor signal                      input terminal</b>	<b>Input low level signals</b>
		<b>IN4: Hard Limit signal                      input</b>	<b>Hard Limit signal input                      terminal</b>	<b>Input low level signals</b>
		<b>IN5: E-stop signal                      input</b>	<b>E-stop signal input terminal</b>	<b>Input low level signals</b>
		<b>IN6: Pedal switch                      signal input</b>	<b>Pedal switch signal input                      terminal</b>	<b>Input low level signals</b>
		<b>IN7: definable</b>	<b>user-defined signal</b>	<b>Input low level signals</b>
		<b>24V+: Sensor power                      input</b>	<b>X、Y、Z sensor isolate circuit                      power supply positive input                      terminal</b>	<b>Sensor isolate circuit                      supply voltage range                      DC10V~DC24V</b>
		<b>GND: GDN                      input</b>	<b>X、Y、Z sensor isolate circuit                      power supply negative input                      terminal</b>	
		<b>Shield: Shield input</b>	<b>Sensor signal cable shield                      input terminal</b>	<b>Do not use this port as a                      negative use of the sensor                      isolation circuit power</b>

ADD.: Beijing haidian district shangdi three street jiahua building A308. P.C.: 100085.

 Dell: 010-62970368 82923063. Fax: 82920078 URL : [www.richnc.com.cn](http://www.richnc.com.cn)

17

Port label	Port definition	Pin Definition	Pin functions and parameters	Notes
	D19	Power LED	Interface board 5V indicator indicate the interface and internal power supply status moderators	Lights after power
	D11	Status indicator	Xorigin status indicator	Light after power. Input low level signal, the lights will be put out. Release the signal, the lights will be bright again
	D12	Status indicator	Yorigin status indicator	
	D13	Status indicator	Zorigin status indicator	
	D14	Status indicator	Tool-setting Status indicator	
	D15	Status indicator	IN4 status indicator	
	D16	Status indicator	IN5 status indicator	
	D17	Status indicator	IN6 status indicator	
	D18	Status indicator	IN7 status indicator	
	D1	Status indicator	output terminal S0 status indicator	Output low level signal when the system works
	D2	Status indicator	output terminal S1 status indicator	
	D3	Status indicator	output terminal S2 status indicator	
	D4	Status indicator	output terminal S3 status indicator	
	D5	Status indicator	output terminal S4 status indicator	
	D6	Status indicator	output terminal S5 status indicator	
	D7	Status indicator	output terminal S6 status indicator	
	D8	Status indicator	output terminal S7 status indicator	

ADD.: Beijing haidian district shangdi three street jiahua building A308. P.C.: 100085.

 Dell: 010-62970368 82923063. Fax: 82920078 URL : [www.richnc.com.cn](http://www.richnc.com.cn)

**PS:** All the pin terminals are for the parties sort the mouth as the first one, the bit serial extended direction of the arrow.

### 3.3 Hardware Connection

Installation Requirements: Switching Power (24V 3A) should add a filter to prevent interference with the electric field. If origin detecting switch are different power supply type, the special testing switching power is needed. (24V origin detecting switch is the best choice)

RichAuto control system realizes its control through the connection between the interface board and CNC machine. Interface board terminal can be divided into input terminal and output terminal :

Input terminal includes :

J8 (input control terminals)

J10 (main power terminals) .

Output terminal includes :

J2 (X axis pulse signal output terminal)

J3 (Y axis pulse signal output terminal)

J4 (Z axis pulse signal output terminal)

J5 (C axis pulse signal output terminal)

J7 (output control terminal)

ADD.: Beijing haidian district shangdi three street jiahua building A308. P.C.: 100085.

Dell: 010-62970368 82923063. Fax: 82920078 URL : [www.richnc.com.cn](http://www.richnc.com.cn)

## Input terminal

1 sensor input ① Mechanical(Y,Z are the same as X)

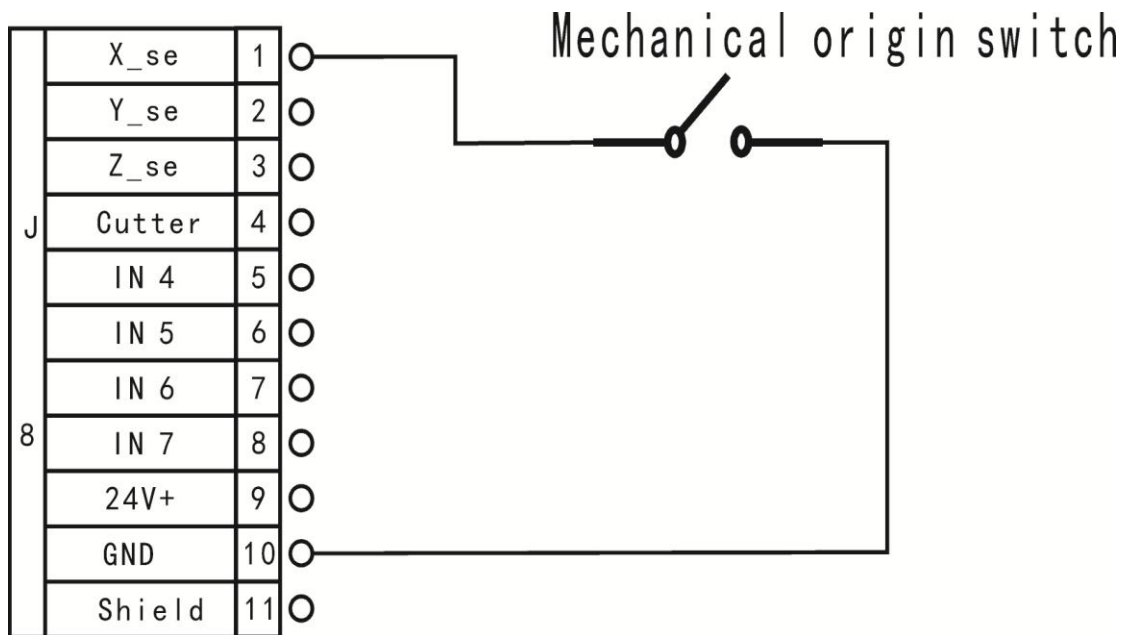

② NPN(NO): Y and Z are the same as X

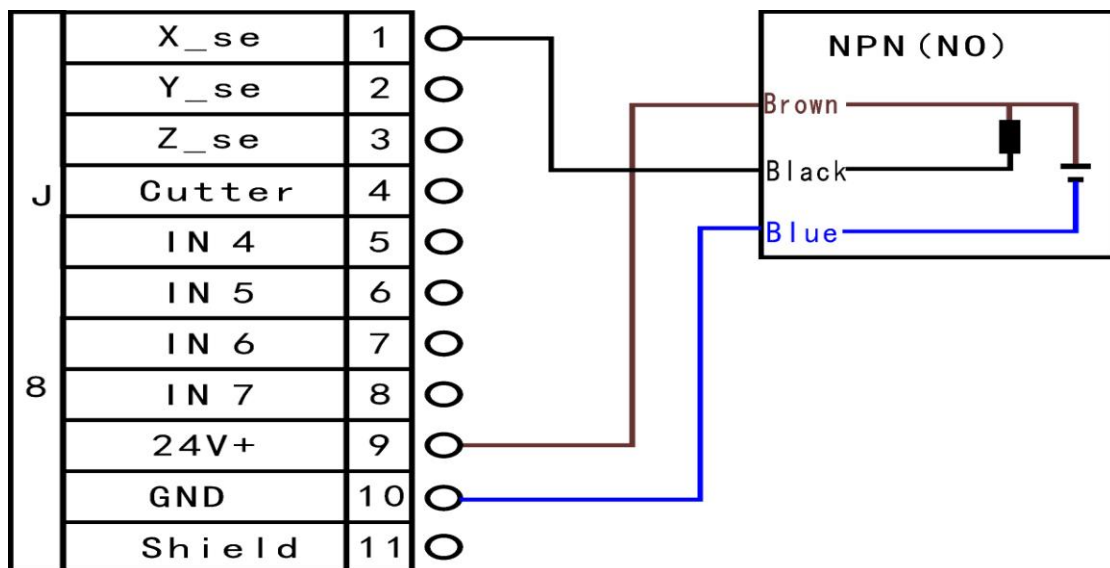

③ PNP(NO) : X and Z are the same as Y

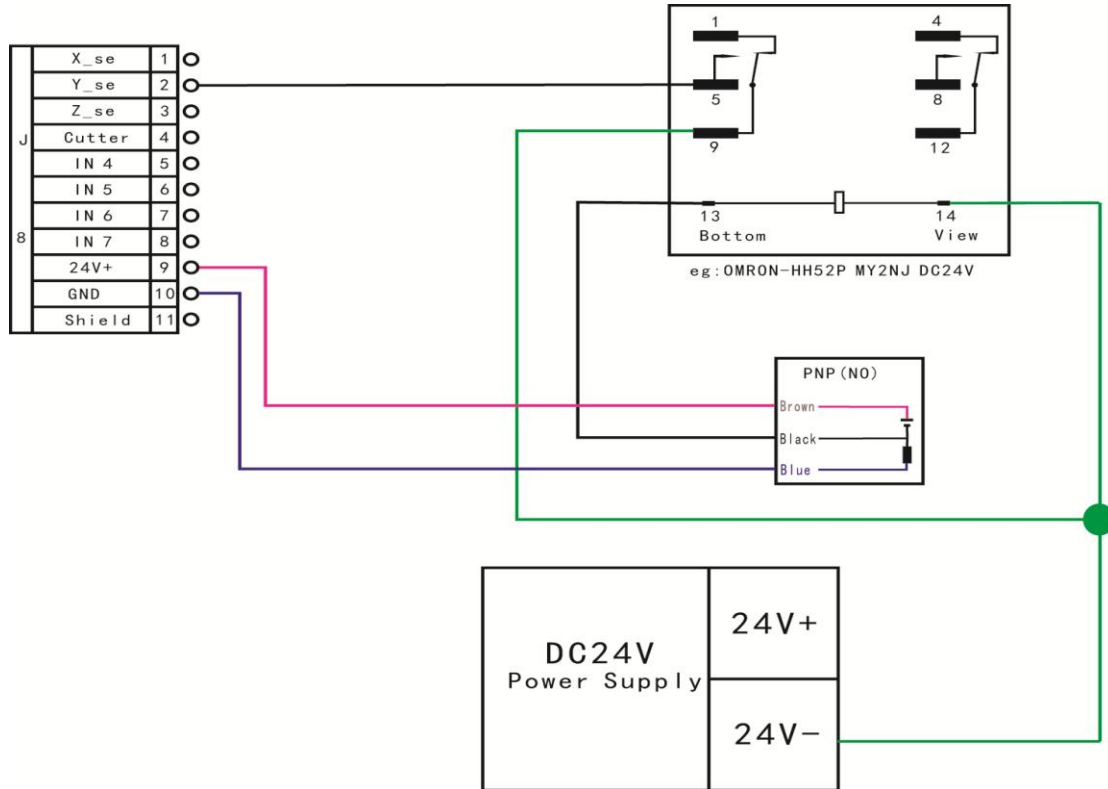

2 Tool-setting input: Tool-setting detecting wiring:

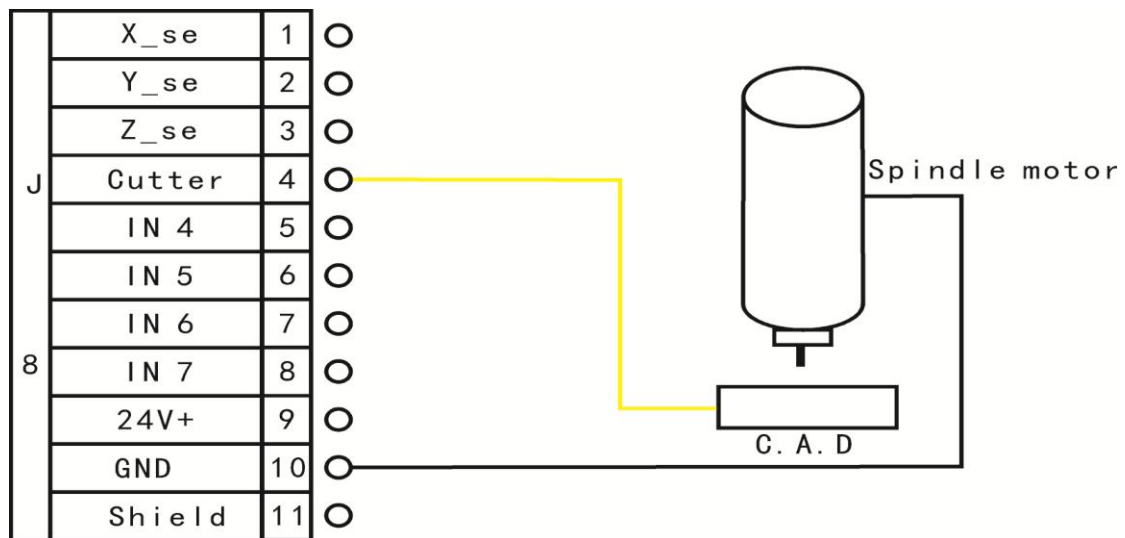

### 3 IN4-IN6 Hard limit,E-stop, Pedal Switch signal

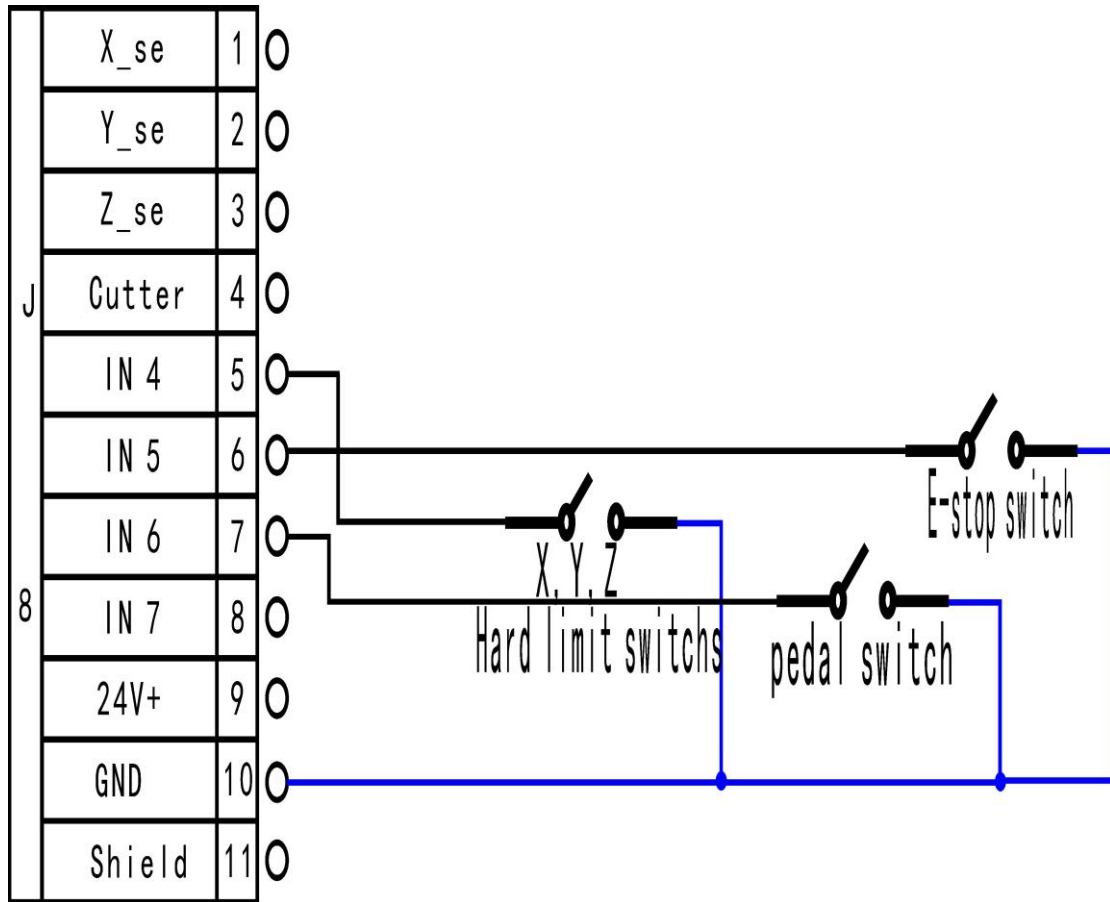

### J10 Main power wiring:

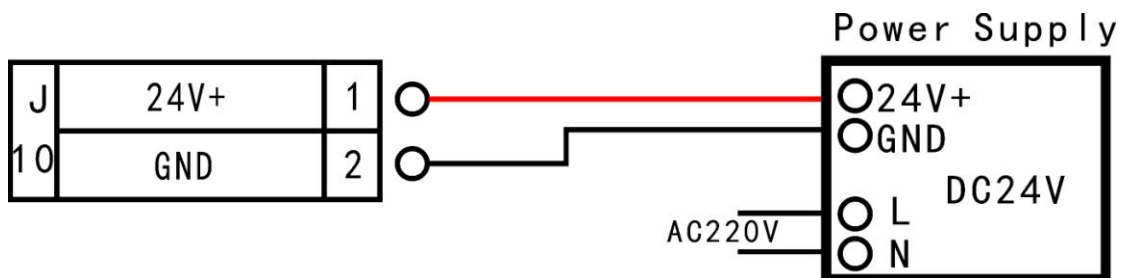

## Output terminal

J2 X pulse signal wiring (Y, Z the same as X)

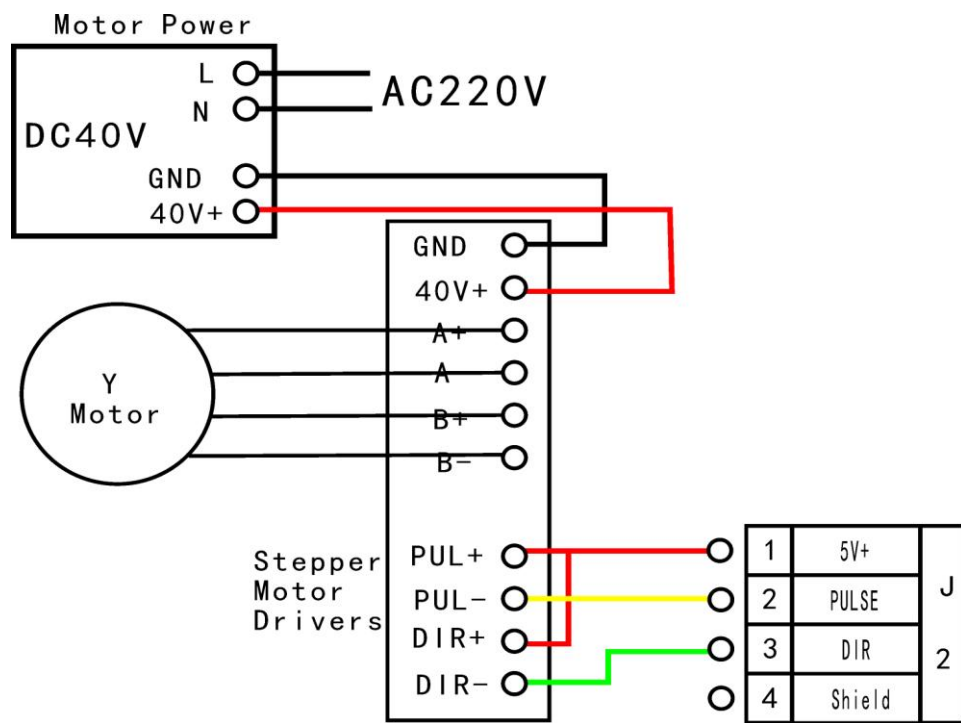

J7 Spindle inverter

2 status: spindle start/stop

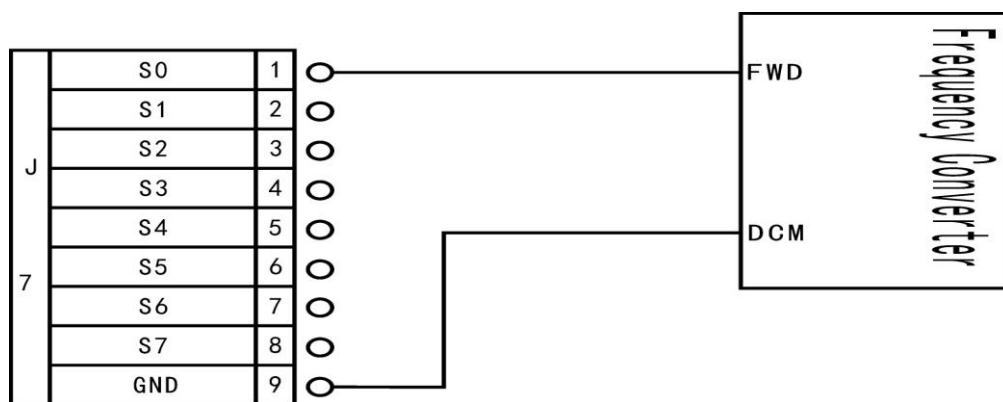

ADD.: Beijing haidian district shangdi three street jiahua building A308. P.C.: 100085.

Dell: 010-62970368 82923063. Fax: 82920078 URL : [www.richnc.com.cn](http://www.richnc.com.cn)



The corresponding spindle setting is:

1 Shift	↓
2 Shift	↑

8 status: spindle start---S1—speed 1, S2—speed 2, Sn—speed n, when spindle stop, the screen displays Fn—the speed before spindle stop.

3 lines,8 status

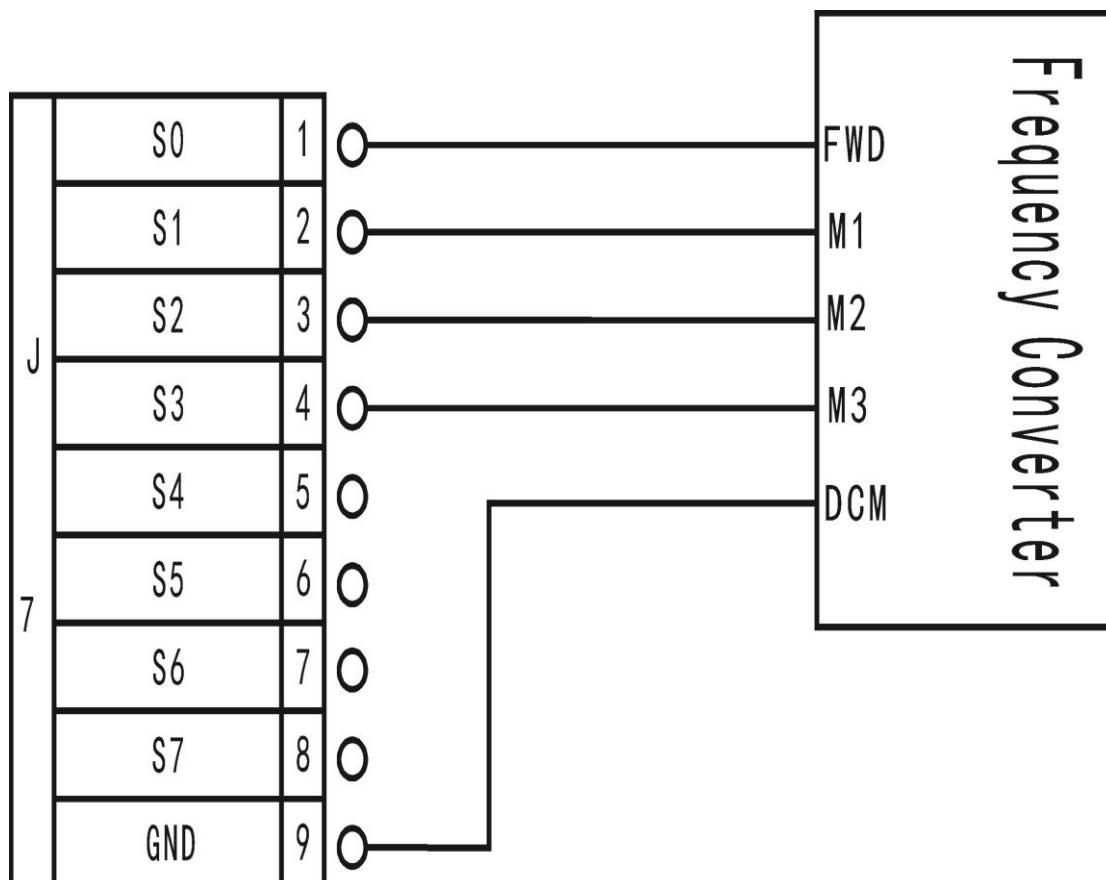

ADD.: Beijing haidian district shangdi three street jiahua building A308. P.C.: 100085.

Dell: 010-62970368 82923063. Fax: 82920078 URL : [www.richnc.com.cn](http://www.richnc.com.cn)

The corresponding spindle setting is:

1 Shift	↓	↓	↓
2 shift	↑	↓	↓
3 shift	↓	↑	↓
4 shift	↑	↑	↓
5 shift	↓	↓	↑
6 shift	↑	↓	↑
7 shift	↓	↑	↑
8 shift	↑	↑	↑

You can completely connect the machine with the control system when the above setting is over.

Output S5 (WORK LED):

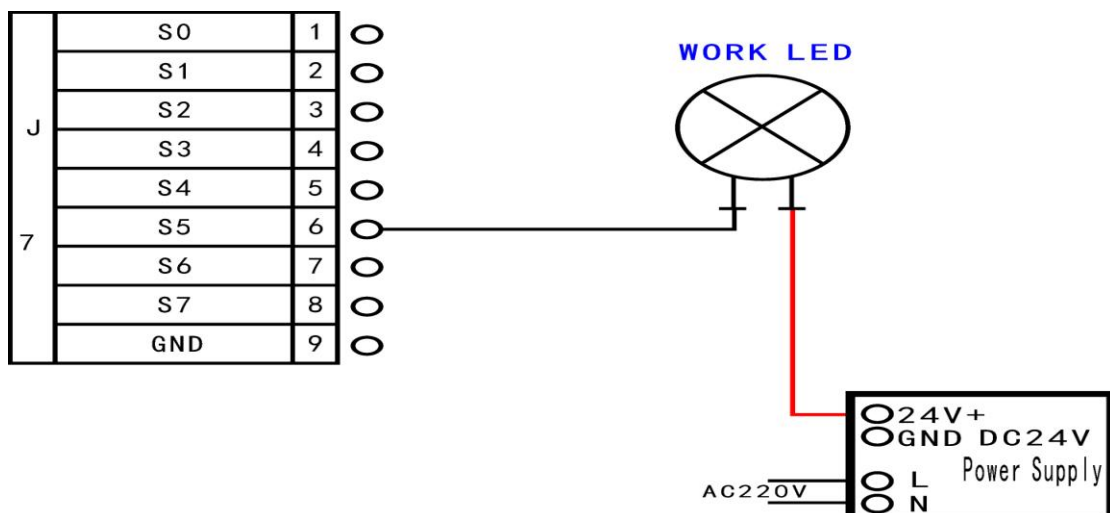

ADD.: Beijing haidian district shangdi three street jiahua building A308. P.C.: 100085.

Dell: 010-62970368 82923063. Fax: 82920078 URL : [www.richnc.com.cn](http://www.richnc.com.cn)

## 3.4 Commissioning of The Machine and Control System

- 1) After turn on the power, you can manually run each axis movement and decide the direction. If the direction of movement and definition direction are opposite, you can set to change the motor phase sequence.
- 2) According to the original location of the machine coordinates, you can enter into menu-machine setting-home setting- home direction to reset it.
- 3) Into menu-machine setup-voltage setup (the upper arrows stand for input voltage) to check whether the home switch is working.

The machine is in good connection if all the above setting is ok.

## 4. Menu direction

### 4.1 Menu category

According to menu function,RICHAUTO system menu can be divided into: **machine setup**、**auto pro setup**、**system setup**、**operate file**、**version view**, every main menu has corresponding submenus.

### 4.2 Menu detail

#### 1. Machine setup:

Machine parameter setup is to set machine hardware. This parameter is set by machine producer according to device type. If machine hardware parameter is not change this parameter should not change. If machine user need to change, please dell

ADD.: Beijing haidian district shangdi three street jiahua building A308. P.C.: 100085.

Dell: 010-62970368 82923063. Fax: 82920078 URL : [www.richnc.com.cn](http://www.richnc.com.cn)

26

to machine producer.

### Machine setup chart

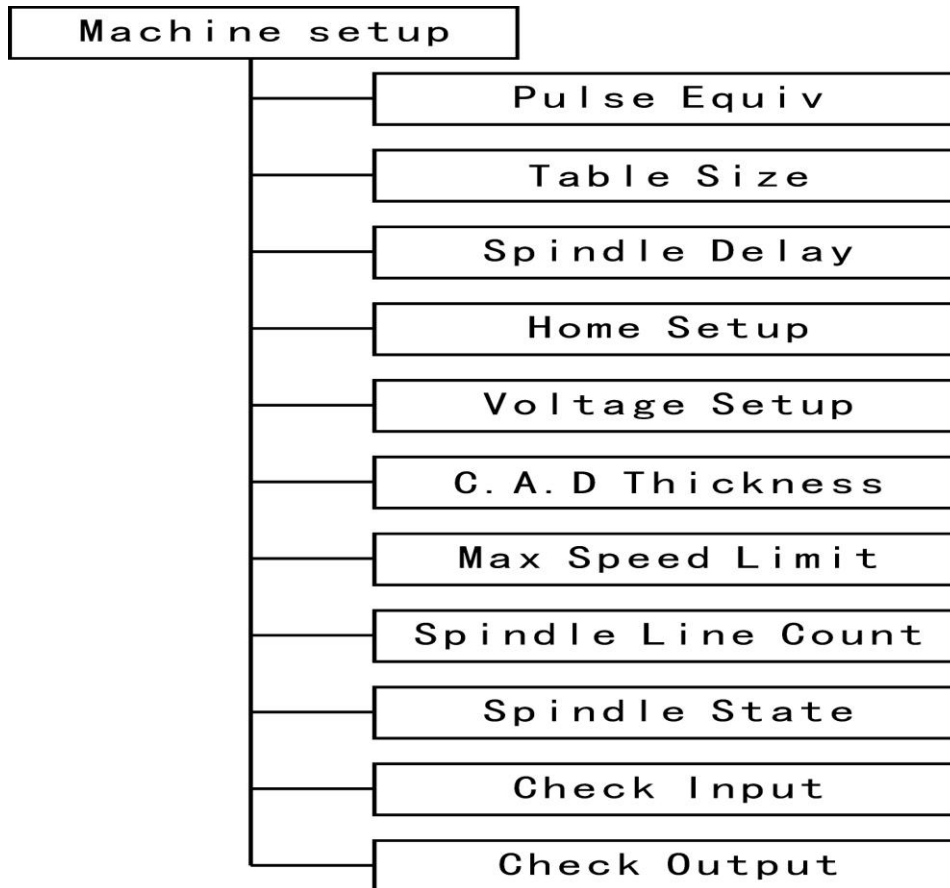

#### (1).pulse equiv:

Control system need to send pulse number when machine move 1 mm, Unit: pulse/mm; Formula = (pulse/r) / (distance/r) r (motor)

Distance/r formula:





ADD.: Beijing haidian district shangdi three street jiahua building A308. P.C.: 100085.

Dell: 010-62970368 82923063. Fax: 82920078 URL : [www.richnc.com.cn](http://www.richnc.com.cn)

Screw drive machine = screw pitch \* mechanical transmission ratio

Rack drive machine = rack module \* gear teeth number \*  $\Pi$  \* mechanical transmission ratio





setting:

choose "pulse equiv", Cursor in the X-axis pulse equivalent, click "", "" move cursor to be modified option, click "", press the number keys to enter values, press "" to save, cursor auto move to next line, in turn modify the Y, Z axis equivalent value, press "", save all value, back to "pulse equiv".

## (2). Table Size

**RichAuto** system make the table size as the soft limit values, in order to prevent machine move over travel, machine size must be less than or equal to the value of the actual motion displacement machine.

setting:

Into "table size", click "" or "" to move cursor to be modified, press "", input modified number, click "" to save, cursor auto

ADD.: Beijing haidian district shangdi three street jiahua building A308. P.C.: 100085.

Dell: 010-62970368 82923063. Fax: 82920078 URL : [www.richnc.com.cn](http://www.richnc.com.cn)



move to next line, in turn change **Y**、**Z** axis values, click "ORIGIN OK" to save all values, back to "table size".

### (3). Spindle Delay:

Set spindle starting time, unit : **ms**: This is also set how long system start spindle after read processing file.

### (4). Home setup:

Home speed : set every axis move speed when machine home, system default speed is X.Y.Z: **6000** MM/Minute.





Home sequence: ① Z, X and Y      ② Z,X,Y  
③ Z,Y,X      ④ Z only  
⑤ X and Y, Z      ⑥ X,Y,Z  
⑦ Y,X,Z      ⑧ XY home  
⑨ X, Y home      ⑩ Y,X home      ⑪ None home

Home direction: set every axis move direction when machine home, this setting depends on the position where home switch in the machine. Such as the return to zero switch installed in the machine positive direction so that home direction should be set "**positive**". and vice versa.

set:

ADD.: Beijing haidian district shangdi three street jiahua building A308. P.C.: 100085.

Dell: 010-62970368 82923063. Fax: 82920078 URL : [www.richnc.com.cn](http://www.richnc.com.cn)

Into "home dir", press " or " to move cursor to be modified, press " to change home direction, click " to save change, back to "home dir".

### (5). Voltage setup:

This used to set input and output signal terminal status, when set ↓ means normal open, the same ↑ normal closed.

Upper and under arrows

Upper Arrows stand for input voltage setup:





Set input voltage signal terminal status. Input voltage top 4(0,1,2,3) corresponding to X zero point, Y zero point, Z zero point, tool setting input signal terminal.

Under Arrows stand for input voltage setup:

Set output voltage signal terminal status. Output voltage top 4(0,1,2,3) corresponding to spindle on/off, multi-step 1, multi-step 2, multi-step 3 output voltage status.

Setting mode:

Into "input voltage setup" and "output voltage setup", press " and

“” to control cursor to be modified . press “”、 “” to get to upper or under arrows, and press “” to change terminal status.

#### (6). C.A.D. Thickness:

This thickness should input by actual, when above actual Z axis will cut over, when low to actual Z axis can't touch workpiece. This parameter can only take effect when user use auto tool change function.

#### (7). Max Spd Limit:

Set machine top speed, this set can only take effect when machine processing, system default max speed X,Y is "60000000", "Z+" is "1800", "Z-" is "3000".

#### (8). Spindle Line Count:

If line=3, Spindle Statues= $2^3=8$

#### (9). Spindle Statue:

When system using multi-step speed to control spindle, user should change this parameter. This parameters must corresponding to spindle output signal terminal wiring sequence. Detail setting please see "spindle setup".

#### (10). Check Input

0-2: X,Y,Z home signal    3: tool setting input signal

4-6: hard limit, E-stop pedal switch signal

ADD.: Beijing haidian district shangdi three street jiahua building A308. P.C.: 100085.

Dell: 010-62970368 82923063. Fax: 82920078 URL : [www.richnc.com.cn](http://www.richnc.com.cn)



### (11). Check Output

0: spindle On/off signal 1-3: Spindle speed signal 4: Tool-change signal

5: Tool-change signal/work LED signal

## 2. Auto pro setup:

This set processing parameters and process files read property.

Auto pro setup menu structure

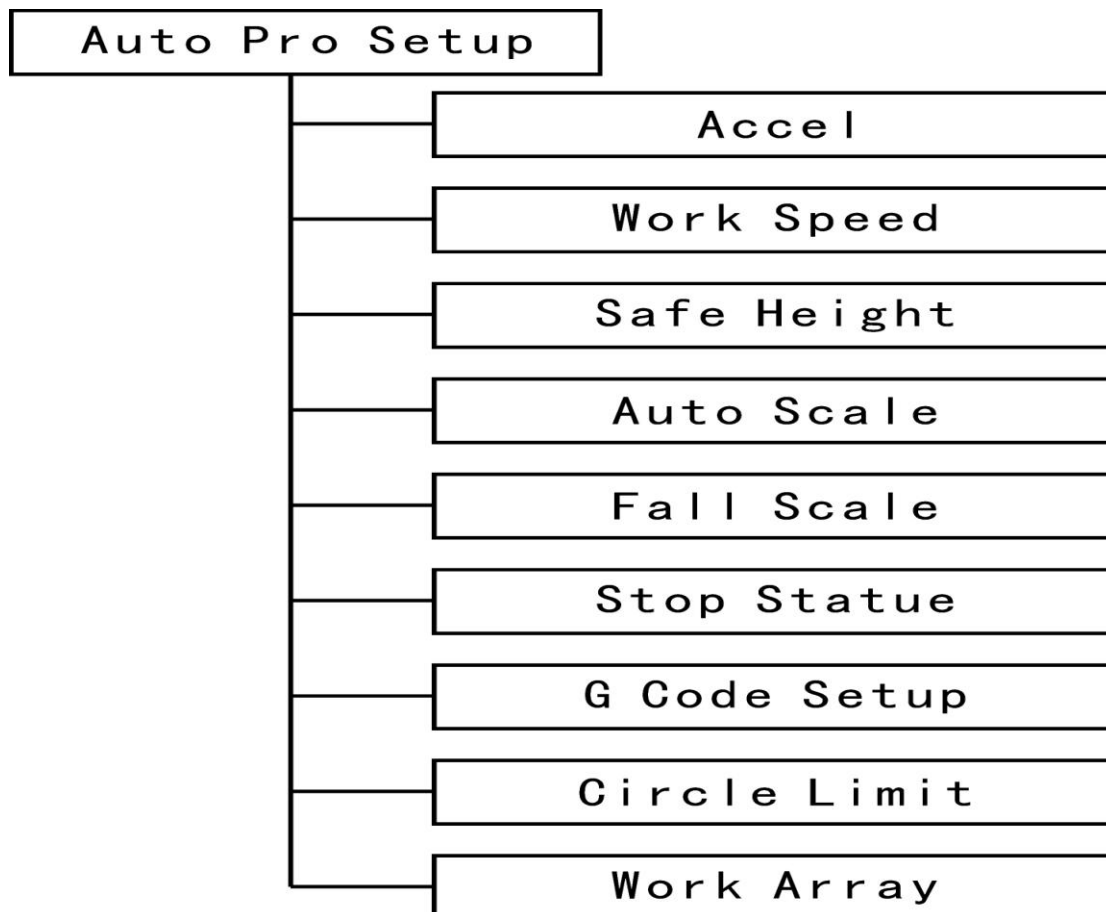

**(1) acceleration :**

This parameter can improve the ability to handling line and curve motion, unit:  
**mm/s<sup>2</sup>**

**(2) work speed: unit:mm/min**

Including work speed and fast speed. system default work spd is 6000;fast spd is 6000.

**(3) Safe height:**

This can tell us how long the file can process. Unit: s.

**(4).Auto scale:**





Auto pro speed=Auto scale\*work speed,it does not affect the fast speed.

**(5).Fall scale:**

Include fall down scale and fall height. system default fall down scale is 0.200,fall height is 5.000mm. Fall down scale takes effect when the spindle falls to the fall height.



**(6).Stop Statue: Setup stop position after auto pro.**

Work stop state	
finish action pickup	
Xcoordinate	0.000
Ycoordinate	0.000
Zcoordinate	0.000

Setup stop position, press “” or “” to where to change the number, and then press “” to input the number needed, press “” to save.

Press “” to get into finish action list

Pickup Z
Back to work origin
Back home
Back position
None move

press “” or “” to where to change the statue, and press “” to save.

### (7).G Code Setup:

Set special code read configure in G code , such as **M**、**T**、**F**、**I**、**J**、**K** , the detail please see "**G Code Setup**"

### (8).Circle Limit:

System default circle limit is 1000.000. unit:mm/min.

### (9).Work Array:

Setup array parameter,include columncount、Rowcount、Columnspace、Rowspace、Interval (unit: ms) .

## 3. System setup:

### System setup menu structure

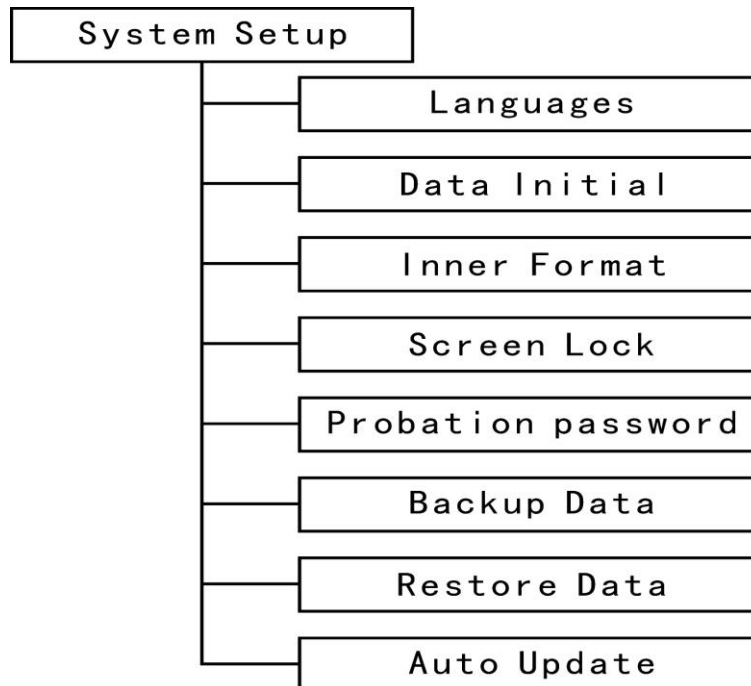

### **(1).** Languages

Change system display language, choose Chinese and English.

### **(2).** Data initial

After data initial system parameters will restore factory setting.

### **(3).** Inner format:

Clean up inner files.

### **(4).** Screen Lock

The screen will lock when the time reaches to the number you setup, and then input the password to unlock the screen.

### **(5).** Probation password

You can get a 20-digit-password from the website of ourcompany.

### **(6).** Backup Data

Back up menu parameters, format system can't effect this.

### **(7).** Restore Data

Restore backup data to system.

### **(8).** Auto Update

Update system online. Support the extension **\*\*\*\*\*.PKG** update file.

## 4. Operate File

### Advanced pro setup menu structures

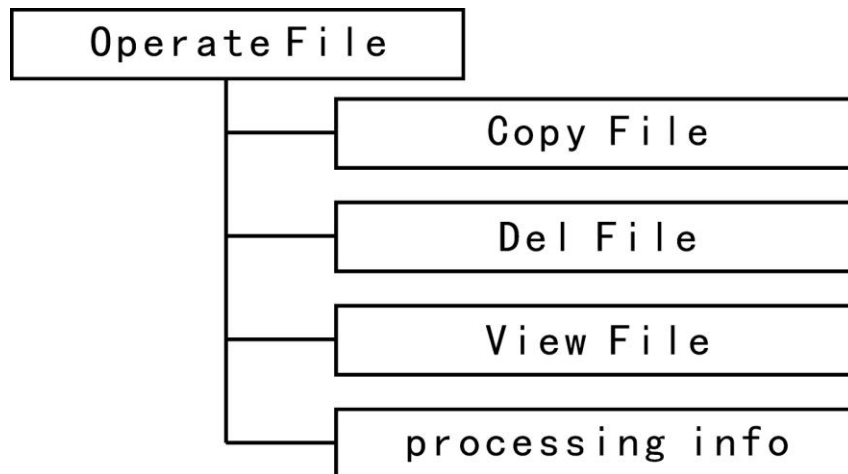

#### (1) Copy File

Copy files of U disk to Inner.

#### (2) Delete File

Delete files of inner.

#### (3) View File

View the files of U disk and inner.

#### (4) Processing information

Statistical the number of files processing successfully.

## 5. Version View

Include: ① Product ID eg: A0020112    ② Soft Version eg: A1.497

③ Emergency Version eg: A1.470    ④ Update Version eg: P1.440

⑤ Soft type

⑥ Hardware type

## 5. Machine operation

### 5.1 Return home

The handle will prompt “All Axis home”、“Z home only”、“none axis home” after starting, choose anyone you want.

In some cases, such as after the last normal shutdown, reboot and continue last operation, users don't need to reset machine, choose “none axis home”. That is because when system quit, it is auto save coordinate value.

### 5.2 Import processing files

Before processing, generally we should import files. There is 2 ways : U disk, inner file process.

1. Directly import processing files to U disk, we can be run.
2. Downloading files into handle by U disk.

## 5.3 Manual processing operation

Manual processing is means we control machine through keyboard. The same we can change operation speed and grid setting. After return home, system into manual status, the screen displays:

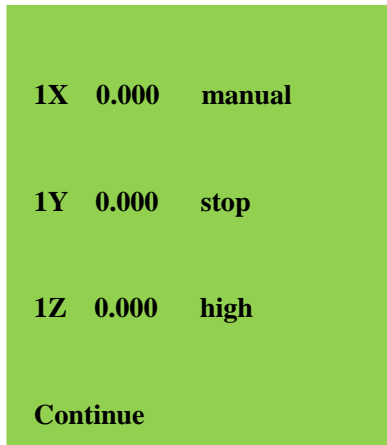

### 1. Manual operation speed adjust

There is two modes: high speed and low speed. We can change mode by

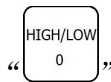







.The screen displays speed mode can decide processing speed.

Speed adjust: in manual mode, press "cannel" to set the current speed mode. If current speed is low speed, it displays as followed:





The cursor in X axis low speed mode , press “” and “” move cursor to be modified , press “” that we can change value, press “” to save, press “” to quit, if number input is wrong, press “” to delete the last number.







In order to ensure the accuracy of processing and debugging, the system introduces the concept of grid. Other systems also call it minimum feed. Its range is: 0.05mm-1.0mm. when user change mode to step, machine will move by grid.

High speed mode setting is the same as low speed mode.

## 2. Manual processing mode

In order to meet manual movement in different situation, this system provides 3 motion modes: continuous, step, distance. We can change mode by “”. The bottom of the screen can display which mode system is on.

### 1) Continuous motion mode

This mode is no special data control, in this mode, press direction key ( 、  
、、、、 ) machine will follow, its speed is decided by current speed mode.

Notice : if user press key's time is too short (shorter than 0.5s), immediately lift buttons, machine will auto move to the nearest grid. It is always stop on grid when this motion mode is over. This motion mode is suitable for crude regulation machine coordinate situation.

## 2) Step motion mode

This mode is always run in low speed, move a grid per 0.5 second , its grid distance is decided by current speed mode. This motion mode is suitable for tool adjust or precise adjust machine coordinate situation.

## 3) Distance motion mode

This mode is run by distance which user is set. When user press directory key

(

X+	Y+	Z+	X-	Y-	Z-
1▲	2▲	3	5▼	6▼	7

), machine will move by set distance.

Notice: Grid can't effect to this motion. It will move by set distance, can't move to grid point.

If user want to change distance, please change to distance mode, re-enter distance value is ok.

## 5.4 Automatic machining operation

Auto processing is means system deal files in U disk and inner by command, this is also called file processing。 Before auto processing, the parameters in system and machine must be correctly set.

ADD.: Beijing haidian district shangdi three street jiahua building A308. P.C.: 100085.

Dell: 010-62970368 82923063. Fax: 82920078 URL : [www.richnc.com.cn](http://www.richnc.com.cn)

41

## Steps:



### 1) Determine the origin of the workpiece

The origin of the coordinate of XYZ in the processing program is the origin of workpiece. Before processing, we should connect the situation to the actual . The operation is as followed:

Move the machine to the situation where the file start processing. Press "

to set the origin of X Y axis, press "

to set Z axis. If used tool setting function, its no need to press "







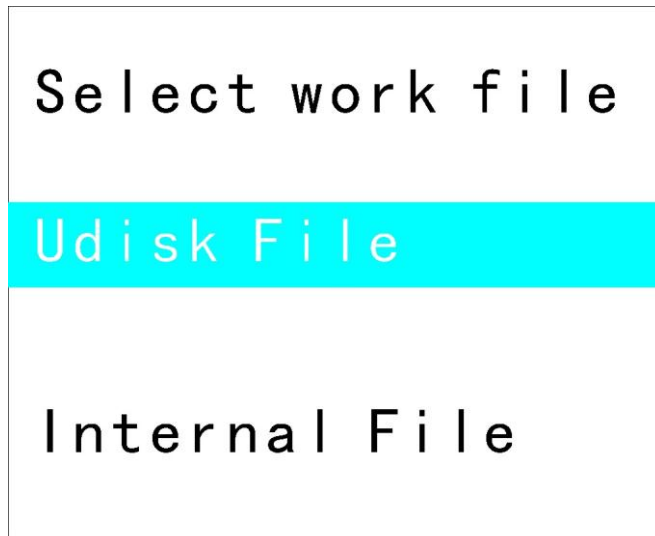

""+ "

### 2) Choose processing files

After determining the origin of workpiece, press "

", the following dialog box appears:









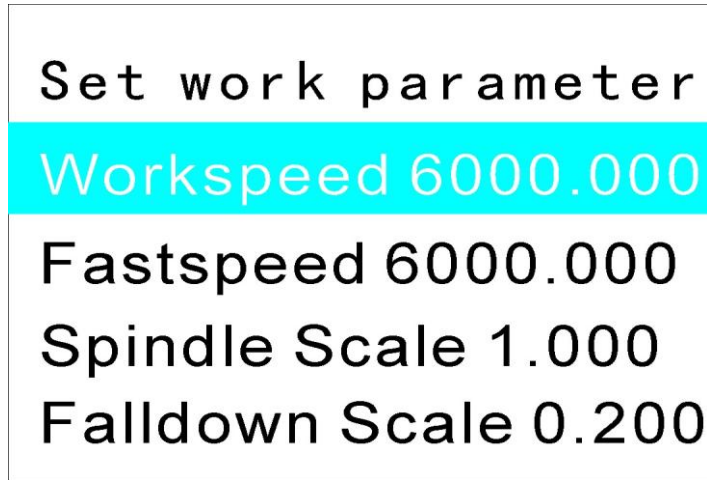

Press “” and “” to move the cursor, press “” to choose the situation, it will displays the first three files, press “” and “” to move cursor, press “” and “” to jump 2 lines, press “” to quit.

### 3) Processing parameters setting

After choosing processing file press “” into setting processing parameters, including processing speed, travel speed, Z down ratio, speed ratio, spindle grad, pulse equivalent, and Z up distance.



Press “” and “” to move cursor to be modified, press “” to set, input value, press “” to save, press “” and “” to select the next. After modifying, press “” to save, system start checking files. It will start processing after checking system. Pulse equivalent there can only display can't be modified. If need to change, please back to “machine setup”. In processing, the screen will display current line, current speed, speed ratio, operating time. We can switch these option by pressing “”。

## 5.5 Processing operations

### 1) Adjust speed ratio and spindle grade





**Adjust speed ratio** In processing, press “” and “” can

ADD.: Beijing haidian district shangdi three street jiahua building A308. P.C.: 100085.

Dell: 010-62970368 82923063. Fax: 82920078 URL : [www.richnc.com.cn](http://www.richnc.com.cn)

44

directly change ratio. current speed = set speed \* ratio, each click “”, ratio down drop 0.1. Speed ratio max 1.0, min 0.1, the display speed will corresponding change, but time will not change.

**Adjust spindle grade** 在此功能生效时系统设置多速。在加工过程中，按下 “” 和 “” 来改变主轴档位。每次点击 “”，上升 1 档，S8 是最高档。每次点击 “”，下降 1 档，直到 S1。

## 2) Processing pause and adjust situation

Press “” to pause, top right corner of the screen will change “run” to “pause”, machine will stop running except spindle. Shown below:

1X	7.200	pauz
1Y	41.300	s-on
1Z	-0.200	step
Line No.	356	

In this time we can adjust situation of 3 axis, the default motion mode is step, speed is low, users can change situation, that is means machine will move a low



speed grid each click; if we need quickly a large range adjust, change the speed

mode to high by press “”, the motion mode change to continuous.

After that, press “”, shown :

1X	7.200	Pauz
1Y	41.300	S-ON
1Z	-0.200	Step
Restore Position?		

System will let users make sure whether to save the modified

Situation, press “”, system will back to situation before modifying; press “”, system will start processing in modified situation.

### 3) Breakpoint processing and power-down protection

**Breakpoint processing** if user want to stop processing in middle , press

“”, shown below:

1X	7.200	RUN
1Y	41.300	S1
1Z	-0.200	1.0
Save break?		

ADD.: Beijing haidian district shangdi three street jiahua building A308. P.C.: 100085.

Dell: 010-62970368 82923063. Fax: 82920078 URL : [www.richnc.com.cn](http://www.richnc.com.cn)

System display "save break?", if we want to save breakpoint, press "ORIGIN OK", LCD displays break list (total 8), press "X+ 1▲" or "X- 5▼" to choose position, and then press "ORIGIN OK" to save, system auto home. If we want to continue processing from breakpoint, we can choose key combination "RUN/PAUSE DELETE +1-8", first hold on press "RUN/PAUSE DELETE", the same time press number key (1-8), release together, system will restore processing from point 1. **If you want to fallback from the breakpoint, press "RUN/PAUSE DELETE", input the line number, and then press "ORIGIN OK", the system will work from the new line number.** Before restore process, system must have a home motion. eg: If we want to continue processing from breakpoint, we can choose key combination "RUN/PAUSE DELETE" + "X+ 1▲", first hold on press "RUN/PAUSE DELETE", the same time press "X+ 1▲", release together, system will restore processing from point 1, the same as 2-8.

#### 4) Power-down protection

when there is a sudden power failure during processing, system will save current

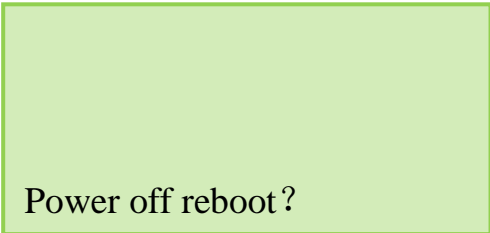

Power off reboot?

coordinate and parameters, when power restart, process continue. Before that,

ADD.: Beijing haidian district shangdi three street jiahua building A308. P.C.: 100085.

Dell: 010-62970368 82923063. Fax: 82920078 URL : [www.richnc.com.cn](http://www.richnc.com.cn)



system must have a home motion, after home, shown as below:

Press “” to continue unfinished process, it will display the stop line, press

“” to cancel process.



## 5.6 Advanced Processing



advanced processing is a function which is satisfied for some special request. It contains: Array work, Resume work, Tool changing, Part work, calculate bound, the

key combination is “” + “” , shown below:

Advance Work
Array work
Resume work
Tool changing
Part work
Calculate bound

### 1) Array work

1. press  and  move cursor to multiple process, press  to



enter, press  and  to select different files;



2. Set process parameters, other operation is the same as general process, system start multiple processing according to users' set;

3. You can also setup in Auto Pro Setup – Work Array.

### 2) Resume work

First we should set multiple process parameters in "advanced setup", then we can use this function. Step is as below:

1. press “” and “” move cursor to Resume work, press “” to

enter. press “” and “” to select different break points, and then

press “”, system will restore processing from the break point.



### 3) Tool changing





Achieve manually change the tools in the position you set. Press “” get

Into the setup, and also press “” back to work origin.

#### 4) Part work



Part work means users can select start line and end line, so part of the processing file can be processed. The step is as below:

① press “” to set, press “” and “” to move cursor to select different file list;

② press “” to enter, press “” and “” to select file, press “”, start to read the file.

③ after read the file, press “” screen displays line 1 of the code, press

“”, prompted “input start number: displays total lines”, input start line to



cursor, press “” to confirm, if line number is wrong, press “” to delete input number.

④ Press “” to the operation of the end line, the screen displays “input

end number”, Press “” the screen displays the changed start number,

ADD.: Beijing haidian district shangdi three street jiahua building A308. P.C.: 100085.



Dell: 010-62970368 82923063. Fax: 82920078 URL : [www.richnc.com.cn](http://www.richnc.com.cn)



press “”, Input end line in cursor, press “” to confirm, press “” to modification;

⑤ Set processing parameters.

## 5) Calculate bound

Calculate area of the file.

① Press “” to set, press “” and “” to move cursor to select different file list;

② Press “” to get into file list, and then press “” and “” to choose file;

③ Press “””, start to read the file, after reading the file, the system will calculate the area.





## PS 1. Handle operating system upgrades

In the process of using handle, there may be some minor problems, these problems update handle software can be restored.

### U disk update

This method is update by handle operation, don't need PC. Update files is \*.PKG. Step is as below:

1、 Save update files to U disk, insert into handle.

2、 Press “”, select “system setup” press “” to enter, press “” and “” move cursor to “**system update**”.

3、 Press “” to enter, select “**U disk files**”, select update files suffix is \*.PKG. System will auto update.

4、 After update, please restart the handle.